

POLARIZATION MODE DISPERSION COMPENSATION IN WDM SYSTEM USING FIBER BRAGG GRATING

AMANDEEP KAUR & NEETU GUPTA

Assistant Professor, Department of ECE, GIMET, Amritsar, Punjab, India

ABSTRACT

In this paper, the polarization mode dispersion in eight channel WDM system is evaluated by considering one even channel and one odd channel performance parameters like BER and Q-factor. As PMD effects transmission at high bit rates so it is compensated with the help of fiber bragg gratings at different distances by controlling the polarising angle with the help of polarization controller at ellipticity $=+45/-45$, azimuth $=0$ corresponding to right hand/left hand circular polarization technique and analyse BER, Q-factor and eye diagram of WDM system. The overall results shows improvements in performance of WDM system.

KEYWORDS: Bit Error Rate (BER), Eye Diagram, Polarization Controller, Polarization Mode Dispersion (PMD), Polarization Schemes, Wavelength Division Multiplexing (WDM), Fiber Bragg Grating (FBG)

1. INTRODUCTION

Due to the rapid increase in the demand for bandwidth, wavelength division multiplexed (WDM) systems have been widely deployed in trans-oceanic links as well as continental and metropolitan networks [1]. There are three polarization effects that lead to impairments in the long-haul optical fiber transmission systems: polarization mode dispersion (PMD), polarization dependent loss (PDL), and polarization dependent gain (PDG) [2]–[4]. In particular, PDG can lead to excess noise in the polarization orthogonal to the signal, and it therefore plays an important role in determining the degradation and variance of the factor. By contrast, dense WDM systems whose channels are spread over a large bandwidth rapidly change their relative polarization states due to PMD so that the overall degree of polarization of the system is nearly zero, and PDG is ineffective. At the same time, different channels experience different amounts of PDL, and, since the amplifiers maintain the total signal power nearly constant, individual channels undergo a kind of random walk so that it is possible for some channels to fade. The index of refraction is changed by the optical power, resulting in a nonlinear birefringence [5]. There are different manifestations of PMD depending on the view taken. There exist special orthogonal pairs of polarization at the input and the output of the fiber called the PSPs. Light launched in a PSP does not change polarization at the output to first order in ω [6]–[8].

These PSPs have group delays, t_g , which are the maximum and minimum mean time delays of the time domain view. The difference between these two delays is called the DGD. The PMD vector describes both the PSPs and the DGD in the fibre. Its PSPs are the polarizations along the principal axes of birefringence of the fibre [9]. In this case the two axes can be treated separately, and in general have different phase shifts ϕ and different group delays $d\phi/d\omega$. One can see that the different values of $\phi(\omega)$ will also produce changes in the output state of polarization as a function of frequency unless the input is launched in one of the PSPs. The DGD grows roughly as the square root of the length of fibre,

as is characteristic of a random walk problem [10]. One commonly accepted parameter used to characterize the PMD delay is the mean DGD across a certain wavelength range ($\Delta\tau$), and is expressed in [ps].

$$\text{PMD} = \langle \Delta\tau \rangle$$

The mean DGD is proportional to the square root of the length of the fiber. The PMD coefficient, $\Delta\tau_c$ [ps/ $\sqrt{\text{km}}$], is used to express the PMD delay as a function of the fiber length. $\Delta\tau = \Delta\tau_c \times \sqrt{L}$; where L is length of the fiber[11].

2. DESIGN TOPOLOGIES

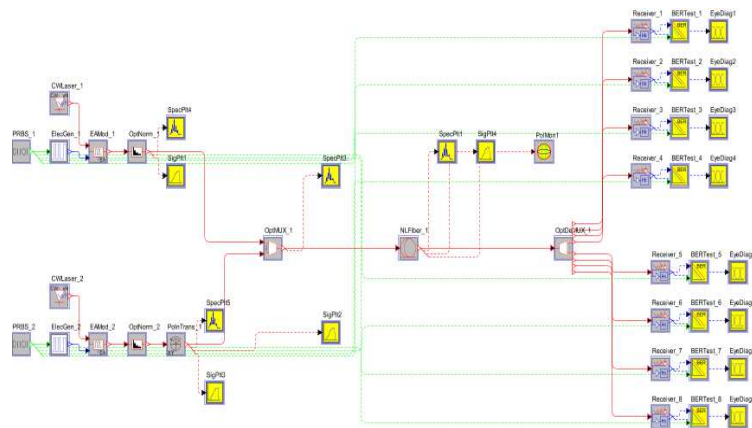

Figure 1: Polarization Mode Dispersion Measurement in WDM System

The system configuration consists of eight channels, which are originated with the help of PRBS generator, continue wavelength laser and electrical signal generator. In the WDM system, each channel is transmitted at the data rate of 10Gbps. So the capacity of the system becomes (10x8) 80Gbps. Polarisation Transform is used to control the polarising angle at ellipticity $+45/-45^0$ and azimuth 0^0 . After multiplexing the signal is transmitted through non linear fibre. The differential group delay, which occurs due to the polarization mode dispersion in the fibre is measured by using polarimeter. In this model we measure the PMD in terms of differential group delay at various distances and the system parameters such as Q- factor, bit error rate etc. are analysed after being demultiplexing. Optical multiplexers and demultiplexers are used here. The estimation of PMD & Comparison of the effect of various polarization states in the WDM system on the basis of performance metrics viz. Q-factor, BER and Eye diagram is carried out at 10Gbps and at various distances.

2.1 Polarization Mode Dispersion Compensation with Fibre Bragg Gratings

In the above system it is observed that in the polarization controller mode with ellipticity= $+45$ and azimuth= 0 the PMD is less than in case of other cases of polarization states. So the polarization controller mode is the better polarization mode among the other polarization modes. In order to further reduce the polarization mode dispersion in the system eight channel WDM system fibre bragg grating are employed which helps to decrease the dispersion in the WDM system. Fibre Bragg Gratings could possibly replace DCF as the standard solution for in-line dispersion compensation. Chirped FBGs have a negligible nonlinearity, low insertion loss and small size [79]-[80]. This potentially allows simpler erbium-doped fibre amplifier (EDFA) design by cascading the FBG and transmission fibre without a mid-stage amplifier, resulting in a significant cost reduction. The main drawback of FBGs is that they suffer from distortions that is caused by imperfections in the gratings fabrication process and limits the number of FBGs that can be cascaded. In the designed

WDM system, I use FBG as a PMD compensator. At 75km distance the non linear fibre exhibits dispersion of $0.09e3$ s/m³ which induce PMD in the WDM link. The fibre Bragg grating of 1.65m long is used here with linear chirp of 0.3nm. The apodisation pattern of grating is uniform for linear chirped gratings. An EDFA is also inserted to support the system so as to improve its performance. At a distance of 100km, FBG used for PMD compensation is 1.5m in length where the linear chirp of 0.4nm is chosen. It greatly reduces the PMD in the WDM system. EDFA with power gain of 10db and power saturation of 8db is used where as at 125km of WDM link, FBG of 2m long and 0.4nm chirp is applied to compensate PMD. An EDFA of suitable power gain and power saturation is used in the given system.

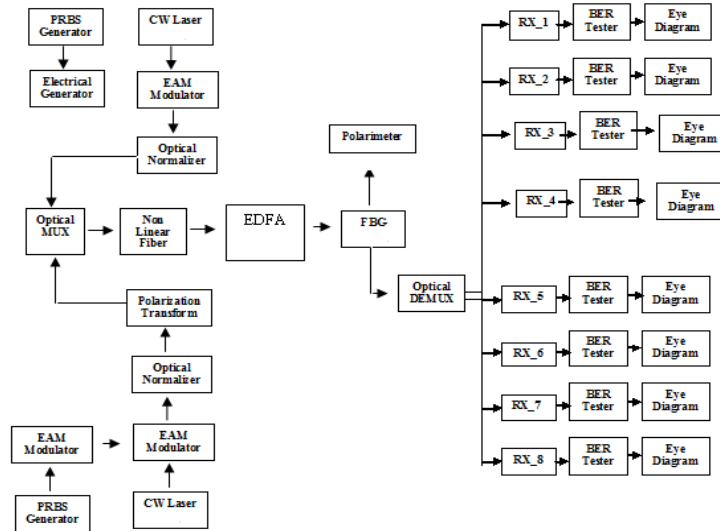

Figure 2: WDM System to Compensate PMD with FBG

3. SIMULATION RESULTS

3.1 PMD at 75km in Polarization Controller Mode

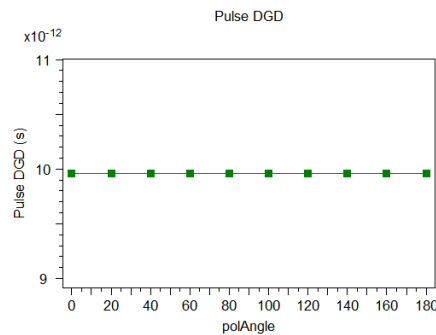

Figure 3.1a: PMD in Polarization Controller with Ellipticity +45 and Azimuth 0.0

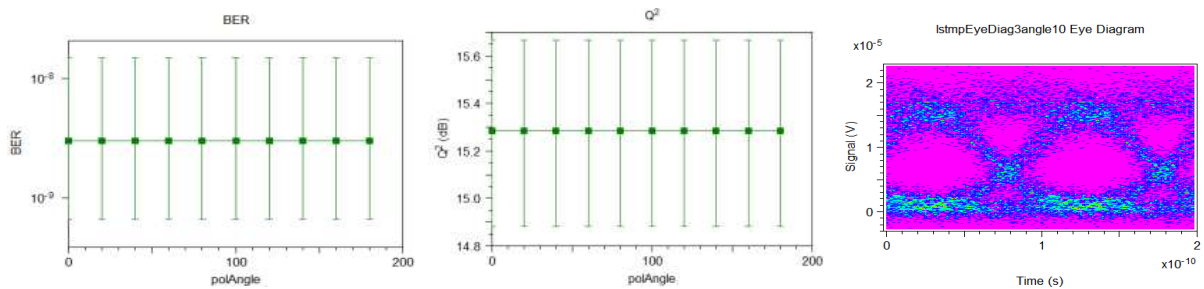

Figure 3.1b: BER, Q-Factor and Eye Diagram of Odd Channel

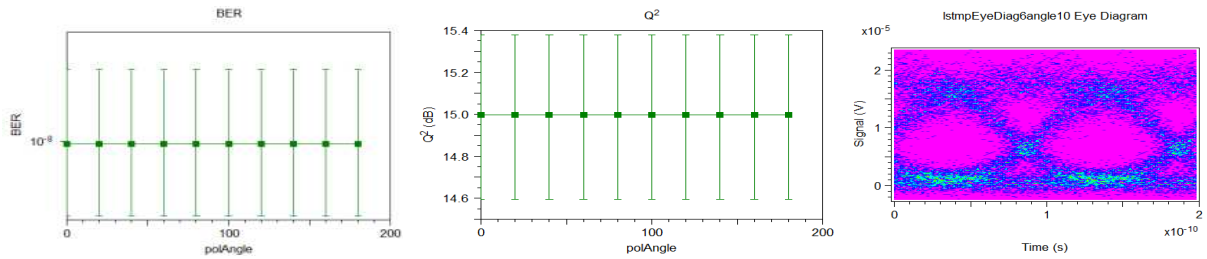

Figure 3.1c: BER, Q-Factor and Eye Diagram of Even Channel

3.2 PMD at 100km Using EDFA Gain of 8db and Saturation Power of 6db in Polarization Controller Mode

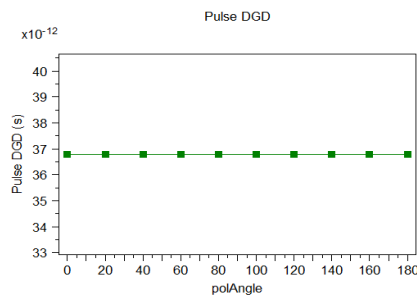

Figure 3.2a: PMD in Polarization Controller Mode

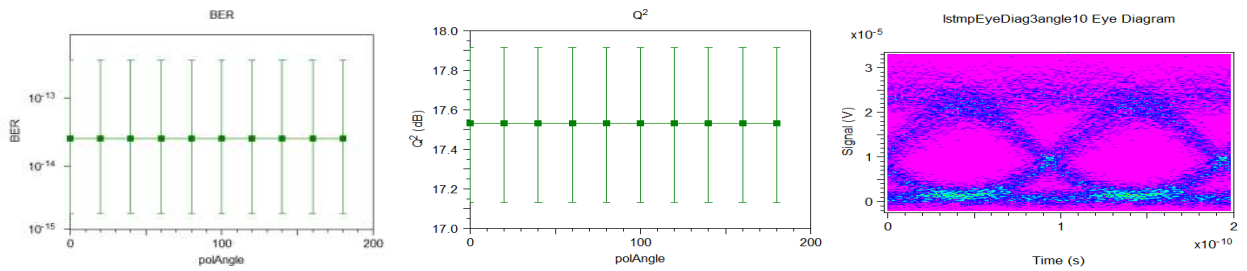

Figure 3.2b: BER, Q-Factor and Eye Diagram of Odd Channel

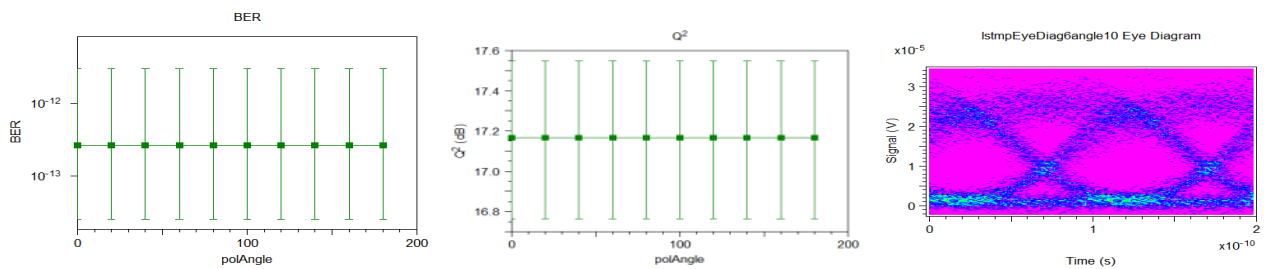

Figure 3.2c: BER, Q-Factor and Eye Diagram of Even Channel

3.3 PMD at 125km Using EDFA in Polarization Controller Mode

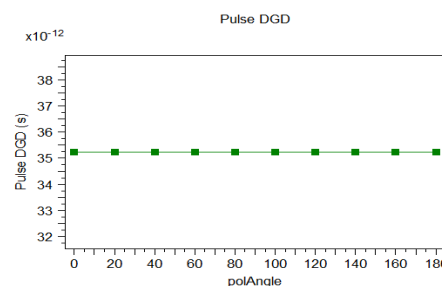

Figure 3.3a: PMD in Polarization Controller Mode with Ellipticity 0, Azimuth +45

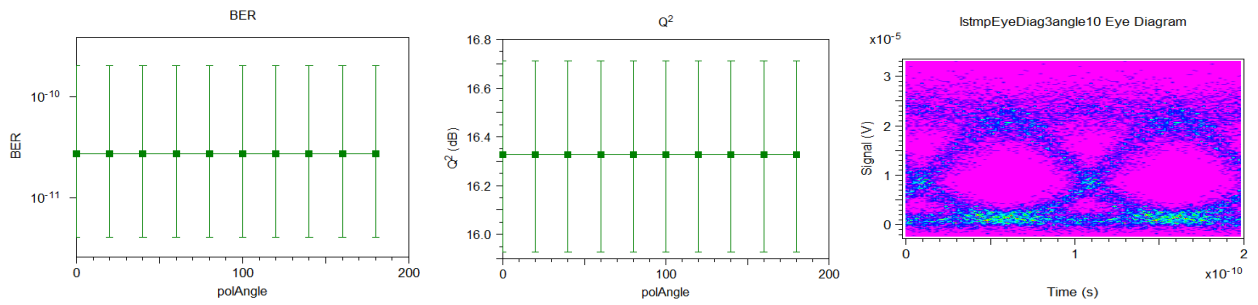

Figure 3.3b: BER, Q-Factor and Eye Diagram of Odd Channel

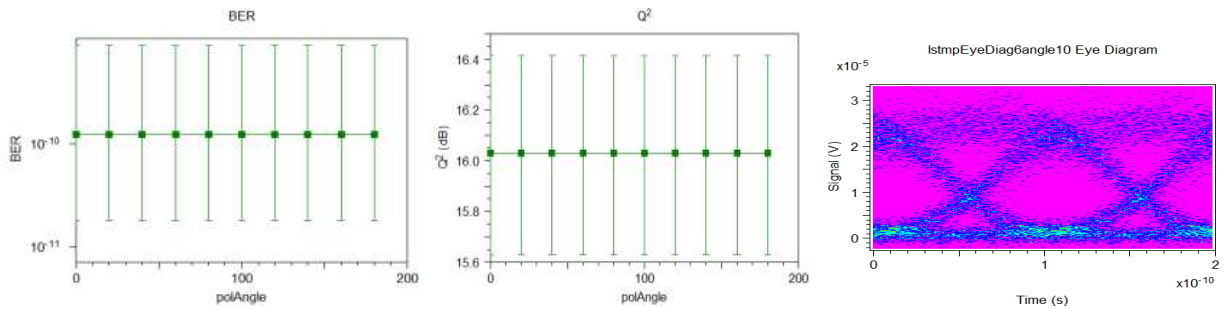

Figure 3.3c: BER, Q-Factor and Eye Diagram of Even Channel

3.4 Compensation of WDM System with Fibre Bragg Grating at 75km in Polarization Controller Mode

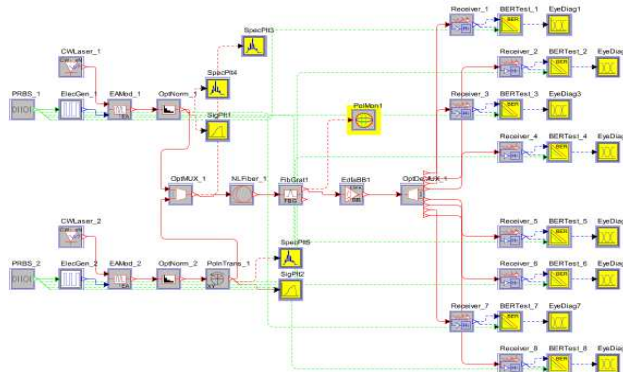

Figure 3.4: Compensation of WDM System with Fibre Bragg Grating at 75km

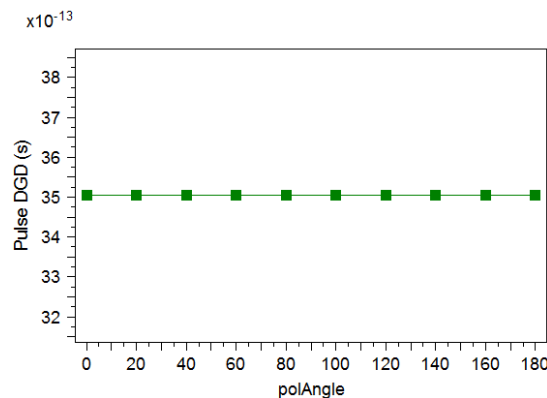

Figure 3.4a: PMD in Polarization Controller Mode after FBG Compensation at 75km

Odd Channel

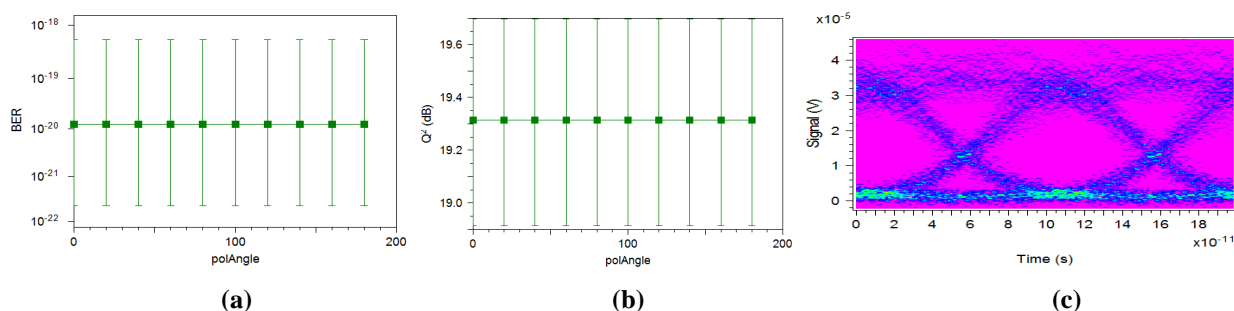

Figure 3.4b: (a) BER (b) Q-Factor and (c) Eye Diagram of Odd Channel after FBG Compensation at 75km

Even Channel

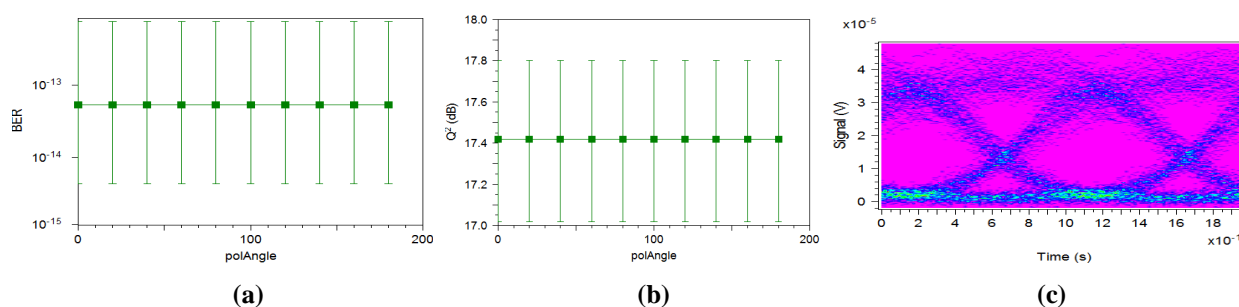

Figure 3.4c: (a) BER (b) Q-Factor and (c) Eye Diagram of Even Channel after FBG Compensation at 75km

RESULTS ANALYSIS

This case of polarization controller mode is corresponding to circular left/right mode; it gives better performance after compensation using FBG. Differential group delay is again constant in this mode and it reduced to 1.7ps. The performance of odd and even channel is given as under.

Table 1

Odd Channel	Even Channel
BER remains same at 10^{-14} at all angles.	BER remains same at all angles at 10^{-13} .
Q- factor remains same at 17.6db.	Q-factor remains same at 17.4db at all angles.
Eye diagram is clear with FBG.	Eye diagram is improved.

The performance of odd channel is better than even channel after using FBG.

3.5 Compensation of WDM System with Fibre Bragg Grating at 100km in Polarization Controller Mode

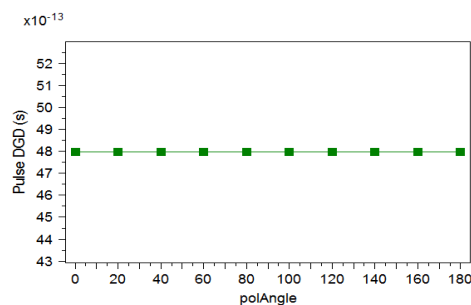

Figure 3.5a: PMD in Polarization Controller Mode after FBG Compensation at 100km

Odd Channel

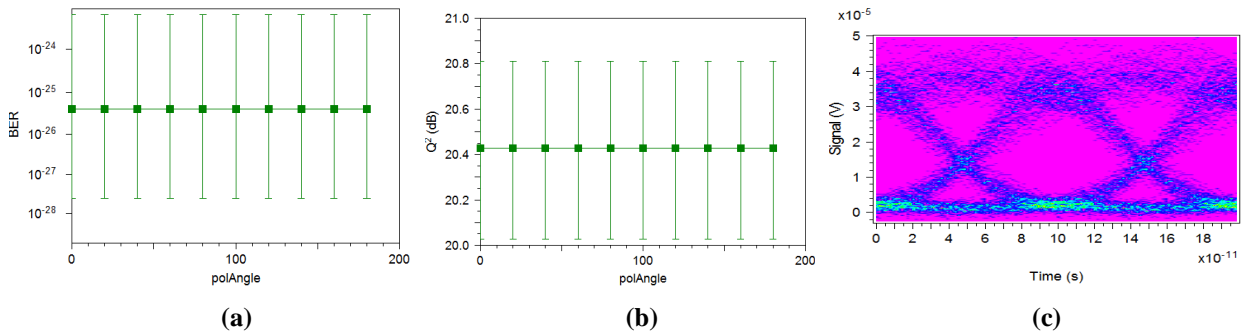

Figure 3.5b: (a) BER (b) Q-Factor and (c) Eye Diagram of Odd Channel after FBG Compensation at 100km

Even Channel

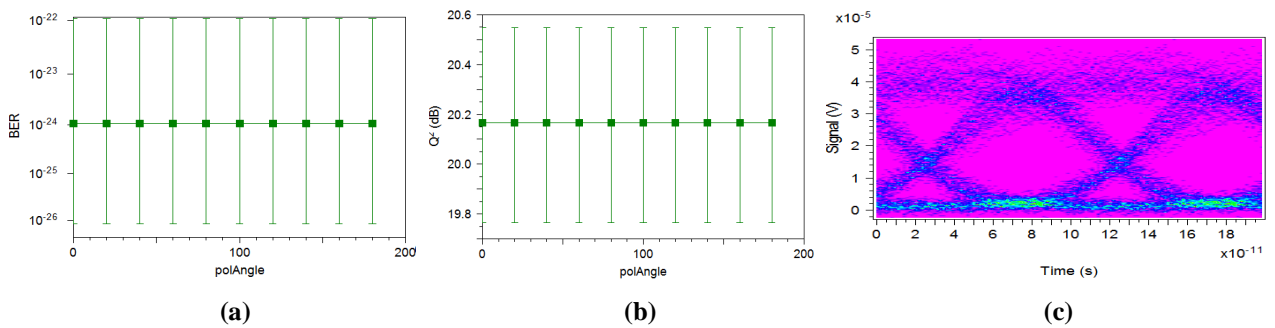

Figure 3.5c: (a) BER (b) Q-Factor and (c) Eye Diagram of Even Channel after FBG Compensation at 100km

RESULTS ANALYSIS

Differential group delay is constant in this mode and it reduced to 2.4ps. The performance of odd and even channel is given as under.

Table 2

Odd Channel	Even Channel
BER remains same at all angles at 10^{-14} .	BER remains at 10^{-24} at all angles.
Q- factor remains same at 17.8db.	Q-factor remains same at all angles at 20.2db.
Eye diagram is clear with FBG.	Eye diagram is improved.

The performance of even channel is better than odd channel after using FBG. The performance of the WDM system is improved with FBG compensation.

3.6 Compensation of WDM System with Fibre Bragg Grating at 125km in Polarization Controller Mode

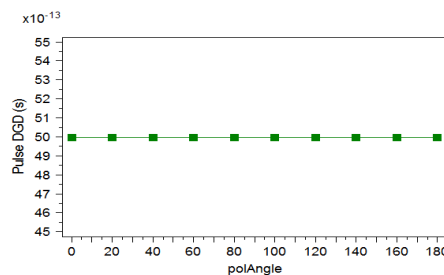

Figure 3.6a: PMD in Polarization Controller Mode after FBG Compensation at 125km

Odd Channel

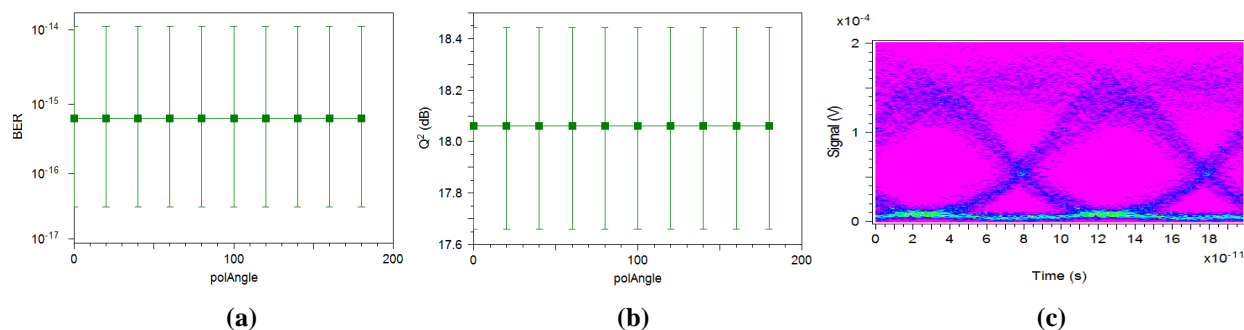

Figure 3.6b: (a) BER (b) Q-Factor and (c) Eye Diagram of Odd Channel after FBG Compensation at 125km

Even Channel

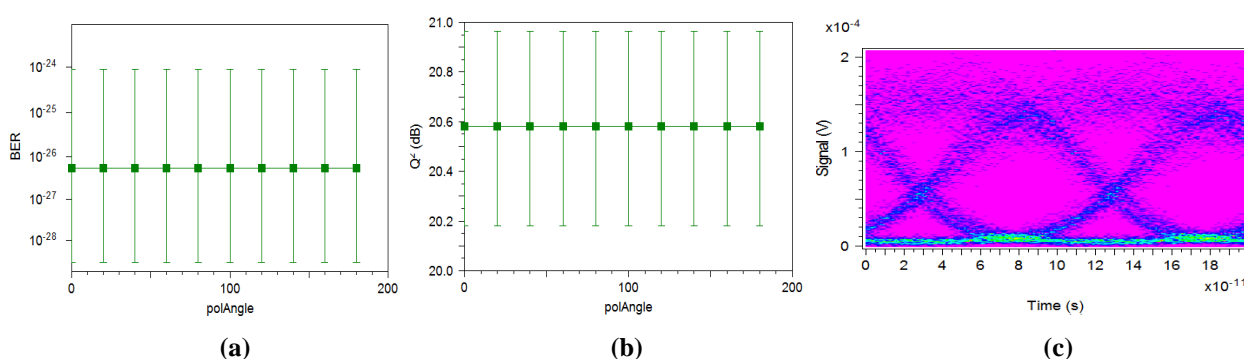

Figure 3.6c: (a) BER (b) Q-Factor and (c) Eye Diagram of Even Channel after FBG Compensation at 125km

RESULTS ANALYSIS

This case of polarization controller mode is corresponding to circular left/right mode; it gives better performance after FBG compensation. Differential group delay is reduced to 2.5ps. The performance of odd and even channel is given as under.

Table 3

Odd Channel	Even Channel
BER remains same at all angles at 10^{-16} .	BER remains same at all angles at 10^{-26} .
Q- factor remains same at 18.4db.	Q-factor remains same at 20.6db at all angles.
Eye diagram is clear with FBG.	Eye diagram is improved.

The performance of even channel is better than odd channel after using FBG at 125km. Eye diagram is better after compensation.

Table 4: Shows the PMD with and without Compensation

Distance (km)	PMD without Compensation (ps)	PMD after FBG Compensation (ps)
75	5	1.7
100	18.5	2.4
125	17.7	2.5

Table 5: Shows the BER of Various Odd and Even Channels of WDM System after PMD Compensation

Distance (km)	BER	
	Odd Channel	Even Channel
	With FBG	With FBG
75	10^{-20}	10^{-13}
100	10^{-25}	10^{-24}
125	10^{-15}	10^{-26}

Table 6: Shows the Q-Factor of Odd and Even Channel of WDM System after PMD Compensation

Distance (Km)	Q-Factor(dB)	
	Odd Channel	Even Channel
	With FBG	With FBG
75	19.3	17.4
100	20.4	20.2
125	18.1	20.6

4. RESULTS AND DISCUSSIONS

The above results show the PMD in WDM system in polarization controller mode. The BER and Q-factor is constant for all the polarization angles. BER is 10^{-9} and 10^{-8} in case of odd and even channel where Q-factor is 15.3dB and 15dB at 75km. The BER at 100km is 10^{-14} and 10^{-13} for odd and even channels which show a small difference, it means BER of all the channels is approachable to acceptable limit where the Q-factor also improves with values 17.6dB and 17.2dB of odd and even channels. At 125km, PMD is 17.7ps and BER is 10^{-11} and 10^{-10} for odd and even channel. The Q-factor of odd channel is 16.3dB and 16dB in the case of even channel.

Table 4 shows the simulations results of PMD compensation in WDM system with fiber bragg grating of various even and odd channels. When the same system is compensated with FBG the PMD induced in the system is 1.7ps. Hence FBG provides compensation of 3.3ps. The grating period of FBG is 5.353m and modulation depth of 2.0×10^{-4} is used. The refractive index of linear chirp grating is 1.45 in this system. The length and chirp of grating is different for various distances of WDM system. At 100km distance, the value of induced PMD in the system is 18.5ps which is reduced to 2.4ps when it is compensated with FBG. It provides almost 16.1ps compensation. The PMD occurs at 125km is 17.7ps. After compensated with FBG it becomes 2.5ps. From these results it is observed that PMD is widely compensated with FBG.

Table 5 shows the BER of various odd and even channels of eight channel WDM system. It is observed that in polarization controller mode its value is constant at all polarization angles. So one odd channel and one even channel is selected to analyse the BER after doing the compensation of the designed link with FBG. The resultant table shows that at 75km BER is 10^{-20} in case of odd channel when these channels are compensated with FBG where as this value is 10^{-13} in case of even channel. As the distance increases to 100km, the BER is improved by inserting EDFA in the WDM system and BER is 10^{-25} in case of odd channel and 10^{-24} in the even channel after compensation. At 125km, the BER of odd channel becomes 10^{-15} and 10^{-26} in case of even channel after compensating the system. In the table 6 the Q factor of various odd and even channels of WDM system is shown after compensation in the polarization controller mode. When the system is compensated the Q-factor is 19.3db at 75km in case of FBG as a compensating device. At the same distance Q-factor is 17.4db in even channel of WDM system. The various values of Q- factor of odd channel after

FBG compensation 20db and 20.2db in case of even channel at 100km. The Q-factor is 18.1db when 125km WDM system is compensated with FBG whereas its value is 20.6db in case of odd channel under FBG compensation.

5. CONCLUSIONS AND FUTURE SCOPE

In the WDM system PMD limits the long distance transmission of optical fibre and if the polarization angle is controlled with the help of polarization controller at ellipticity = $+45/-45$ and azimuth = 0, which is corresponding to right/left circular polarization then the overall results show improvement in BER, Q-factor and Eye diagrams of various channels. The value of BER varies from 10^{-13} to 10^{-26} for different odd and even channels at various distances, which is acceptable and Q-factor of 17.4 to 20.6 also provide better system performance when it gets compensated with FBG. In future this topology can be enhanced to calculate PMD at bit rates higher than 10Gbps, at larger distances and for more number of channels using different methods. Different optical compensation methods can be used to further improve the system capacity at larger distances and also at higher bit rates.

REFERENCES

1. L. E. Nelson, et. al 2001, "Observation of PMD-induced coherent crosstalk in polarization-multiplexed transmission," IEEE Photon Technol. Lett., vol. 13, July no. 7, pp. 738–740.
2. N. S. Bergano and C. R. Davidson, 1996, "Wavelength division multiplexing in long-haul transmission systems", J. Lightwave Technol. Vol. 14 (6), pp-1299.
3. E. Lichtman, 1995, "Limitations imposed by polarization-dependent gain and loss on all-optical ultralong communication systems," J. Lightwave Technol., May, Vol. 13, pp. 906–913.
4. C. D. Poole, et. al, 1991, "Fading in lightwave systems due to polarization-mode dispersion," IEEE Photon. Technol. Lett., Jan, Vol. 3, pp. 68–70.
5. N. S. Bergano, 1996, "Wavelength division multiplexing in long-haul transmission systems," J. Lightwave Technol., June, Vol. 14, pp. 1299–1308.
6. C. D. Poole and R. E. Wagner, 1986, "Phenomenological approach to polarization dispersion in long single-mode fibers," Electron. Lett., Vol. 22, pp. 1029–1030.
7. C. D. Poole, et. al, 1991, "Fading in lightwave systems due to polarization-mode dispersion," IEEE Photon. Technol. Lett., Jan, Vol. 3, pp. 68–70.
8. T. Takahashi and M. Aiki, 1994, "Automatic Compensation Technique for Timewise Fluctuating Polarization Mode Dispersion in In-line Amplifier Systems", Electronics Letters, February, Vol.: 30, n° 4, p. 348.
9. C. Francia, et. al, 1999, "Simple Dynamic Polarization Mode Dispersion Compensator," Electronics. Letter, March, vol.3, pp.
10. F. Heismann and D. A. Fishman 1998, "Automatic Compensation of First-Order Polarization Mode Dispersion in a 10 Gb/s Transmission System", Proc. ECOC'98, September.
11. G.P. Agrawal, 1995, Nonlinear Fiber Optics, second ed., Academic Press, New York.